

Article number: 03445045

Description: Fluro Heavy Duty Spherical Plain Bearing GE 45 EW-2RS  
Hole Ø45

Note: 45

## Measures

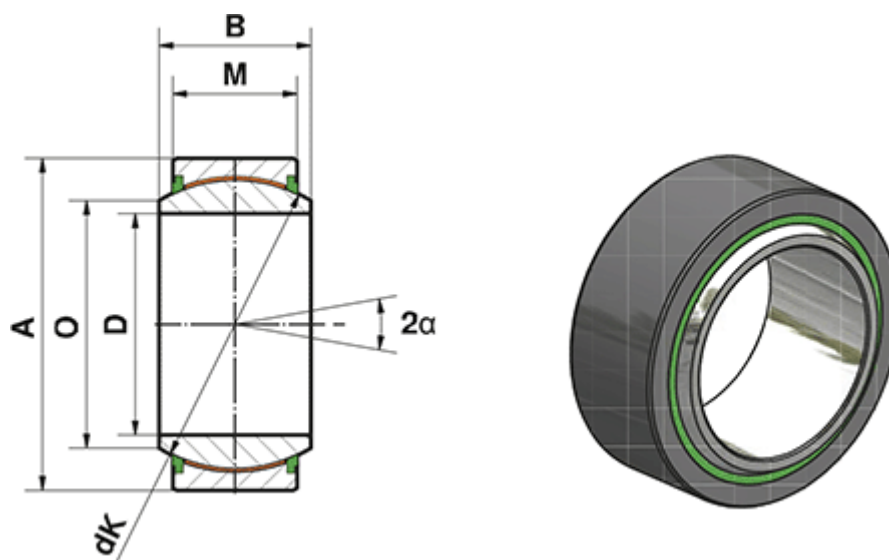

A	= 68	Static load C0 (kN) = 600
a (degrees)	= 7	Weight (g) = 390
B	= 32	
D	= 45	
dk	= 60	
Dynamic load C (kN)	= 360	
M	= 25	
O	= 50.7	